



Copyright @ ICbanQ Inc.

TW 2017-09-27

VER:A1

Tel:82-070-7019-3947 Email:Tommy@icbanq.com

DATE2017-09-27

Customer:

Li-ion Polymer Battery Specification

MODEL: TW501646 - 300mAh

Prepared By	Checked By	Approved By

Customer Approval	Signature Date
	Company Name
	Company Stamp



Copyright @ ICbanQ Inc.

TW 2017-09-27

VER:A1

Tel:82-070-7019-3947 Email:Tommy@icbanq.com

DATE2017-09-27

Amendment Records

Edition	Description	Prepared by	Approved by	Date
A	First Edition			



Copyright @ ICbanQ Inc.

TW 2017-09-27

VER:A1

Tel:82-070-7019-3947 Email:Tommy@icbanq.com

DATE2017-09-27

1.Scope

This specification is applied to the reference battery in this Specification and manufactured Copyright @ ICbanQ Inc.

2. Product Specification

Table 1

No.	Item	General Parameter		Remark
1	Rated Capacity	Typical	300mAh	Standard discharge(0.2C C ₅ A) after Standard charge
		Minimum	280mAh	
2	Nominal Voltage	3.7V		Mean Operation Voltage
3	Voltage at end of Discharge	2.4V ± 0.1V		Discharge Cut-off Voltage
4	Charging Voltage	4.28 ± 0.05V		
5	Internal Impedance	≤280m Ω		Internal resistance measured at AC 1KHz after 50% charge The measure must uses the new batteries that within one week after shipment and cycles less than 5 times
6	Standard charge	Constant Current 0.5C ₅ A Constant Voltage 4.2V 0.01 C ₅ A cut-off		Charge time : Approx 4.5h
7	Standard discharge	Constant current 0.5 C ₅ A end voltage3.0V		
8	Fast charge	Constant Current 1.0C ₅ A Constant Voltage 4.2V 0.01 C ₅ A cut-off		Charge time : Approx 4h



Copyright @ ICbanQ Inc.

TW 2017-09-27

VER:A1

Tel:82-070-7019-3947 Email:Tommy@icbanq.com

DATE2017-09-27

Continuous the table 1

No.	Item	General Parameter	Remark
9	Fast discharge	Constant current 1.0 C ₅ A end voltage 3.0V	
10	Maximum Continuous Charge Current	1.0 C ₅ A	
11	Maximum Continuous Discharge Current	1.0 C ₅ A	
12	Operation Temperature Range	Charge: 0~45°C	60± 25%R.H. Bare Cell
		Discharge: -20~60°C	
13	Storage Temperature Range	Less than 1 year: -20~25°C	60± 25%R.H. at the shipment state
		less than 3 months: -20~40°C	
14	Product Dimension	Height: Max 47mm	Initial Dimension
		Width: Max 16.5mm	
		Thickness: Max 5.2mm	
15	Cycle life	With a current of 0.2C charge and discharge the battery to make the loop and recording the capacity until the battery capacity is low as 80% of the initial capacity.	Battery should not explode smoke, burn or burst. charge and discharge cycle life should more than 300 times

	Copyright @ ICBanQ Inc.	TW 2017-09-27
		VER:A1
	Tel:82-070-7019-3947 Email:Tommy@icbanq.com	DATE2017-09-27

3.Performance And Test Conditions

3.1 Standard Test Conditions

Test should be conducted with new batteries within one week after shipment from our factory and the cells shall not be cycled more than five times before the test. Unless otherwise specified, test and measurement shall be done under temperature of $20 \pm 5^{\circ}\text{C}$ and relative humidity of 45~85%. If it is judged that the test results are not affected by such conditions, the tests may be conducted at temperature 15~30°C and humidity 25~85%RH.

3.2 Measuring Instrument or Apparatus

3.2.1 Dimension Measuring Instrument

The dimension measurement shall be implemented by instruments with equal or more precision scale of 0.01mm.

3.2.2 Voltmeter

Standard class specified in the national standard or more sensitive class having inner impedance more than $10\text{k}\Omega/\text{V}$

3.2.3 Ammeter

Standard class specified in the national standard or more sensitive class. Total external resistance including ammeter and wire is less than 0.01Ω .

3.2.4 Impedance Meter

Impedance shall be measured by a sinusoidal alternating current method(1kHz LCR meter).

3.3 Standard Charge\Discharge

3.3.1 Standard Charge Test procedure and its criteria are referred as follows:

$0.5C_5A = 150\text{mA}$

Charging shall consist of charging at a $0.5C_5A$ constant current rate until the cell reaches 4.2V.

The cell shall then be charged at constant voltage of 4.2 volts while tapering the charge current. Charging shall be terminated when the charging current has tapered to $0.01 C_5A$.

Charge time : Approx 4.0h, The cell shall demonstrate no permanent degradation when charged between 0°C and 45°C .

3.3.2 Standard Discharge

$0.2C_5A = 60\text{mA}$

Cells shall be discharged at a constant current of $0.2 C_5A$ to 3.0 volts @ $20 \pm 5^{\circ}\text{C}$

3.3.3 If no otherwise specified, the rest time between Chare and Discharge amount to 30min.

3.4 Appearance

There shall be no such defect as flaw, crack, rust, leakage, which may adversely affect commercial value of battery.

3.5 Initial Performance Test

Table 2

Item	Test Method and Condition	Requirements
(1) Open-Circuit Voltage	The open-circuit voltage shall be measured within 24 hours after standard charge.	$\geq 4.18V$
(2) Internal impedance	Internal resistance measured at AC 1KHz after 50% charge	$\leq 180m\ \Omega$
(3) Minimal Rated Capacity	The capacity on $0.2C_{5A}$ discharge till the voltage tapered to 3.0V shall be measured after rested for 30min then finish standard charge.	Discharge Capacity $\geq 280mAh$

3.6 Temperature Dependence of discharge capacity

Cells shall be charged per 3.3.1 and discharged @ $0.2 C_{5A}$ to 3.0 volts. Except to be discharged at temperatures per Table 3. Cells shall be stored for 3 hours at the test temperature prior to discharging and then shall be discharged at the test temperature. The capacity of a cell at each temperature shall be compared to the capacity achieved at 23°C and the percentage shall be calculated. Each cell shall meet or exceed the requirements of Table 3.

Table 3

Discharge Temperature	-10°C	0°C	23°C	60°C
Discharge Capacity $0.2 C_{5A}$	70%	85%	100%	85%

3.7 Cycle Life and Leakage-Proof

Table 4

No.	Item	Criteria	Test Conditions
1	Cycle Life (0.5 C ₅ A)	Higher than 80% of the Initial Capacities of the Cells	Carry out 300cycle Charging/Discharging in the below condition. Charge:Standard Charge, per 3.3.1 Discharge:0.5 C ₅ A to 3.0 V Rest Time between charge/discharge:30min. Temperature:20±5°C
2	Leakage-Proof	No leakage (visual inspection)	After full charge with standard charge, store at 60±3°C, 60±10%RH for 1 month.

3.8 Product characteristics curve

3.8.1 Charge curve with different rate

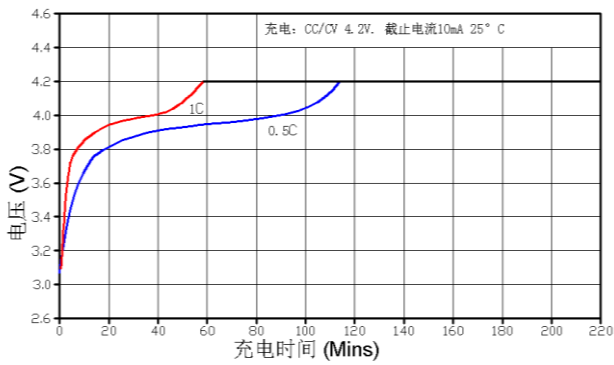

3.8.2 Different rate discharge curves

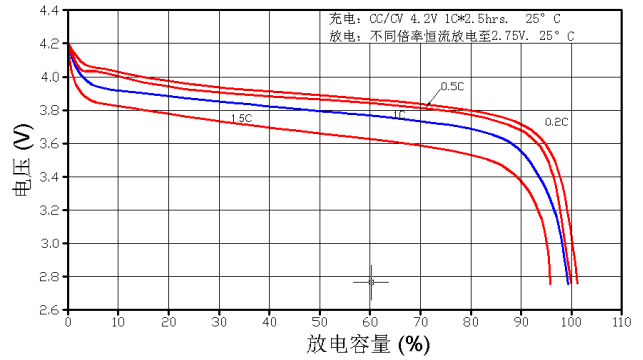

3.8.3 Discharge curves at different temperatures

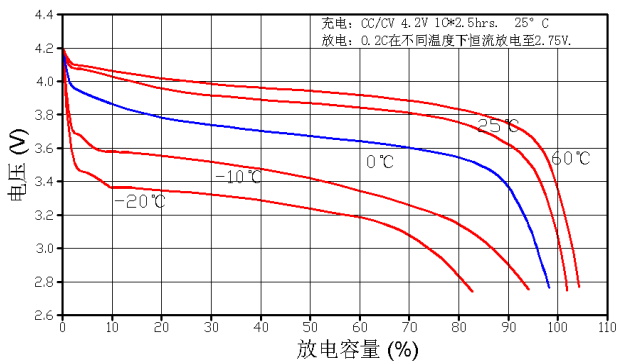

3.8.4 Cycle life curve

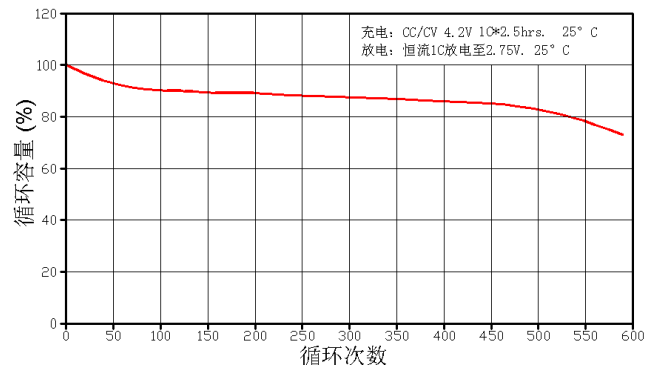

4. Mechanical characteristics and Safety Test

Table 5

(Mechanical characteristics)

No.	Items	Test Method and Condition	Criteria
1	Vibration Test	The standard charge batteries is fixed on the vibration table, vibration for 10 minutes, CPM test speed: 150-150, the vibration frequency of 2.5 Hz ~ 3 Hz,	12 to 24 hours after the testing, finished product testing are not allowed to have a bad product
2	Drop Test	The cell is to be dropped from a height of 1 meter twice onto concrete ground.	No explosion, No fire, no leakage.

Table 6

(Safety Test)

Item	Battery Condition	Test Method	Requirements
Short Circuit 20°C	Fresh, Fully charged	Each test sample battery, in turn, is to be short-circuited by connecting the (+) and (-) terminals of the battery with a Cu wire having a maximum resistance load of 0.1 Ω .Tests are to be conducted at room temperature($20 \pm 2^\circ\text{C}$).	No explosion, No fire The Temperature of the surface of the Cells are lower than 150°C
Short Circuit 60°C	Fresh, Fully charged	Each test sample battery, in turn, is to be short-circuited by connecting the (+) and (-) terminals of the battery with a Cu wire having a maximum resistance load of 0.1 Ω .Tests are to be conducted at temperature($60 \pm 2^\circ\text{C}$).	No explosion, No fire The Temperature of the surface of the Cells are lower than 150°C
Forced Discharge	Fresh, Fully charged	Discharge at a current of 1 C ₅ A for 2.5h.	No explosion, No fire

5. Handling of Cells

5.1 Consideration of strength of film package

1) Soft Aluminium foil

Easily damaged by sharp edge parts such as pins and needles, Ni-tabs, comparing with metal-can-cased LIB.

2). Sealed edge may be damaged by heat above 100°C, bend or fold sealed edge.

5.2 Prohibition short circuit

Never make short circuit cell. It generates very high current which causes heating of the cells and may cause electrolyte leakage, gassing or explosion that are very dangerous.

The LIP tabs may be easily short-circuited by putting them on conductive surface.

Such outer short circuit may lead to heat generation and damage of the cell.

An appropriate circuitry with PCM shall be employed to protect accidental short circuit of the battery pack.

5.3. Mechanical shock

LIP cells have less mechanical endurance than metal-can-cased LIB.

Falling, hitting, bending, etc. may cause degradation of LIP characteristics.

5.4 Handling of tabs

The battery tabs are not so stubborn especially for aluminum tab.

Don't bend tab.

Do not bend tabs unnecessarily.

6. Notice for Designing Battery Pack

6.1 Pack toughness

Battery pack should have sufficient strength and the LIP cell inside should be protected from mechanical shocks.

6.2 Cell fixing

The LIP cell should be fixed to the battery pack by its large surface area.
No cell movement in the battery pack should be allowed.

6.3 Inside design

No sharp edge components should be inside the pack containing the LIP cell.

6.4 Tab connection

Ultrasonic welding or spot welding is recommended for LIP tab connection method.
Battery pack should be designed that shear force are not applied to the LIP tabs.

If apply manual solder method to connect tab with PCM, below notice is very important to ensure battery performance:

- The solder iron should be temperature controlled and ESD safe;
- Soldering temperature should not exceed 350°C;
- Soldering time should not be longer than 3s;
- Soldering times should not exceed 5 times, Keep battery tab cold down before next time soldering;
- Directly heat cell body is strictly prohibited, Battery may be damaged by heat above approx. 90°C

6.5 For mishaps

Battery pack should be designed not to generate heat even when leakage occurs due to mishaps.

- 1) Isolate PCM (Protection Circuit Module) from leaked electrolyte as perfectly as possible.
- 2) Avoid narrow spacing between bare circuit patterns with different voltage.
(Including around connector)
- 3) LIP battery should not have liquid from electrolyte, but in case If leaked electrolyte touch bare circuit patterns, higher potential terminal material may dissolve and precipitate at the lower potential terminal, and may cause short circuit. The design of the PCM must have this covered.

7. Notice for Assembling Battery Pack

Shocks, high temperature, or contacts of sharp edge components should not be allowed in battery pack assembling process.

8. Others

8.1.Cell connection

- 1) Direct soldering of wire leads or devices to the cell is strictly prohibited.
- 2) Lead tabs with pre-soldered wiring shall be spot welded to the cells.
Direct soldering may cause damage of components, such as separator and insulator, by heat generation.

8.2.Prevention of short circuit within a battery pack

Enough insulation layers between wiring and the cells shall be used to maintain extra safety protection.

The battery pack shall be structured with no short circuit within the battery pack, which may cause generation of smoke or firing.

8.3. Prohibition of disassembly

1) Never disassemble the cells

The disassembling may generate internal short circuit in the cell, which may cause gassing, firing, explosion, or other problems.

2) Electrolyte is harmful

LIP battery should not have liquid from electrolyte flowing, but in case the electrolyte come into contact with the skin, or eyes, physicians shall flush the electrolyte immediately with fresh water and medical advice is to be sought.

8.4 Prohibition of dumping of cells into fire

Never incinerate nor dispose the cells in fire. These may cause explosion of the cells, which is very dangerous and is prohibited.

8.5 Prohibition of cells immersion into liquid such as water

The cells shall never be soaked with liquids such as water, seawater, drinks such as soft drinks, juices, coffee or others.

8.6 Battery cells replacement

The battery replacement shall be done only by either cells supplier or device supplier and never be done by the user.

8.7 Prohibition of use of damaged cells

The cells might be damaged during shipping by shock. If any abnormal features of the cells are found such as damages in a plastic envelop of the cell, deformation of the cell package, smelling of an electrolyte, an electrolyte leakage and others, the cells shall never be used any more.

The Cells with a smell of the electrolyte or a leakage shall be placed away from fire to avoid firing or explosion.

9. Period of Warranty

The period of warranty is a year from the date of shipment. Power Tech International guarantees to give a replacement in case of cells with defects proven due to manufacturing process instead of the customer abuse and misuse.

10. Storing the Batteries

The batteries should be stored at room temperature, charged to about 30% to 50% of capacity. We recommend that batteries be charged about once per half a year to prevent over discharge.

11. Other The Chemical Reaction

Because batteries utilize a chemical reaction, battery performance will deteriorate over time even if stored for a long period of time without being used. In addition, if the various usage conditions such as charge, discharge, ambient temperature, etc. are not maintained within the specified ranges the life expectancy of the battery may be shortened or the device in which the battery is used may be damaged by electrolyte leakage. If the batteries cannot maintain a charge for long periods of time, even when they are charged correctly, this may indicate it is time to change the battery.

12.Note:

Any other items which are not covered in this specification shall be agreed by both parties.

13. Protection Circuit:

Using scope: The specification only applies to Li-ion battery protection module,

Environment request ROHS

13.1 SPECIFICATIONS

T_{opt}=25°C

Item	symble	Description	Criteria
Overcharge	V _{DET1}	Overcharge detection voltage	4.28 ± 0.05V
	tV _{DET1}	Over charge protection delay time	0.2s MAX
	V _{REL1}	Over charge release voltage	4.1 ± 0.15V
Over discharge	V _{DET2}	Over discharge protection voltage	2.4 ± 0.1V
	tV _{DET2}	Over discharge protection delay time	120ms MAX
	V _{REL2}	Over discharge release voltage	3.0 ± 0.1V
Over current	V _{DET3}	Over current detection voltage	150 ± 30mV
	I _{DP}	Over current detection current	3A ± 1A
	tV _{DET3}	Over current protection delay time	20msMAX
		0 V battery charge function	Available
Short circuit protection	T _{SHORT}	Short protection delay time	120µs MAX
		Protection Condition	Open Short Circuit
Impedance	R _{DS}	Impedance of MOS tube internal resistance	R _{DS} ≤ 60m Ω
Current consumption	I _{DD}	Internal circuit consumption during operation	MIN:2.0 µ A
			MAX:6.0 µ A

13.2 Circuit Diagram

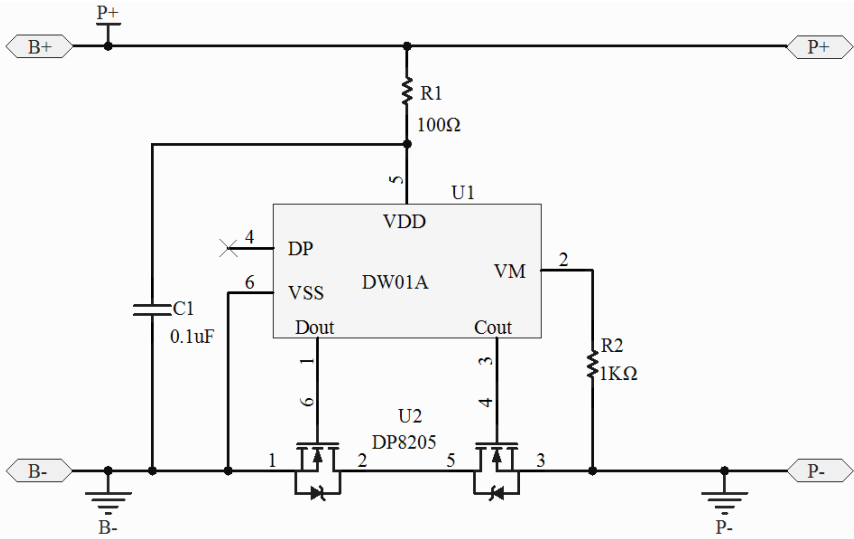

13.3 PARTS LIST

NO.	Symbol	Description	Spec. Model	Pack Type	Q' ty
1	U1	IC	DW01	SOT-23-6	1
2	U1	MOSFET	8205A	SOT-23-6	1
3	R1	Resistance	SMD100Ω±5%	0603	1
4	R2	Resistance	SMD1kΩ±5%	0603	1
5	C1	Capcistance	SMD0.1uF±20%	0603	1
6		PCB	16.0*3.5*0.6/±0.1mm		1

Size Spec		Dimension	
T:	5.0+0.3 /-0.4mm		
W:	16.0+0.5 /-0.5mm		
H:	47.0+1.5 /-0.5mm		
Wire L:	50mm/+5/-5mm		
Wire (Ø):	1.0±0.02 mm		
Connector	1.25pitch		
Printed words	- TW 501646 3.7V +300mAh 1.11Wh Date 		
L1:	1.25mm		