

---

# PRODUCT SPECIFICATION

**MODEL: MTF043055B0-40**

<◇> PRELIMINARY SPECIFICATION

<◆> APPROVAL SPECIFICATION

<b>CUSTOMER</b>
<b>APPROVED BY</b>
<b>DATE:</b>

DESIGNED	CHECKED	APPROVED
		

**PREPARED BY:**



---

# CONTENTS

- GENERAL DESCRIPTIONG
- GENERAL FEATURES
- ABSOLUTE MAXIMUM RATINGS
- ELECTRICAL SPECIFICATIONS
- OPTICAL SPECIFICATIONS
- BLOCK DIAGRAM
- PIN DESCRIPTION
- OUTLINE DIMENSION
- REGISTER VALUE
- TIMING CHARACTERISTICS
- RELIABILITY AND INSPECTION STANDARD
- INSPECTION CRITERION
- PACKING DIMENSION
- PRECAUTIONS

## 1. General Description

The MTF043055B0-40 model is a Color TFT LCD supplied by MICROTECH Technology Co.,LTD. This main Module has a 4.3 inch diagonally measured active display area with 480(RGB)X272 resolution. Each pixel is divided into Red, Green and Blue sub-pixels and dots which are arranged in vertical stripes.

LCD color is determined with 262,000 colors signal for each pixel.

The MTF043055B0-40 has been designed to apply the interface method that enables low power, high speed, and high contrast.

The MTF043055B0-40 is intended to support applications where thin thickness, wide viewing angle and low power are critical factors and graphic displays are important.

## 2. General Features

Item	Display Panel	Remark
Display Mode	Normally White, Transmissive LCD	
Viewing Direction	12 O'CLOCK	
Input Signals	RGB	
Outside Dimensions	105.5mm(W)*67.2mm(H)*3.0mm(T)	
Effective Area	-	
Active Area	95.04mm(W)×53.856mm(H)	
Number of Pixels	480×RGB×272Pixels	
Pixel Pitch	0.198mm(H) × 0.198mm(W)	
Pixel Arrangement	RGB Vertical stripes	
Drive IC	ST7282	

## 3. Absolute Maximum Ratings

The following are maximum values which, if exceeded may cause operation or damage to the unit.

ITEM	Symbol	Min.	Typ.	Max.	Unit	Remark
Power for Circuit Driving	VDD		3.2		V	
Power for Circuit Logic	VCI		3.2		V	
LC Operating Voltage *1)	Vop		3.3		V	
LED Forward Voltage	V <sub>f</sub>	-	22.4	-	V	
LED Forward Current	I <sub>r</sub>	-	20	-	mA	
LCD Luminance	B <sub>P</sub>	-	250	-	cd/m <sup>2</sup>	
Storage Humidity	H <sub>ST</sub>	10	-	90	%RH	At 25±5°C
Storage Temperature	T <sub>ST</sub>	-30	-	80	°C	
Operating Ambient Humidity	H <sub>OP</sub>	10	-	90	%RH	
Operating Ambient temperature	T <sub>OP</sub>	-20	-	70	°C	

Note:

- \*1) Liquid Crystal driving voltage.  
Due to the characteristics of LC Material, this voltage vary with environmental temperature.
- \*2) Temp. >60°C, Absolute humidity shall be less than 90%RH at 60°C
- \*3) Temp. ≤60°C, 90%RH MAX.

## 4. Electrical Specification Main Window Display

(Unless specified, the ambient temperature Ta=25°C)

Properties	Sym.	Min	Typ.	Max	Unit	Note
Power for Circuit Driving	VDD		3.2		V	Note
Power for Circuit Logic	VCI		3.2		V	Note
BLU Driving Logic	Vbat	-	-	-	V	
Logic Input Voltage	Low Voltage	VIL	0	-	0.2VDD	V
	High Voltage	VIH	0.8VDD	-	VDD	V
Logic Output Voltage	Low Voltage	VOL	0	-	0.1VDD	V
	High Voltage	VOH	0.9VDD	-	VDD	V
Power Consumption	White	P <sub>w</sub>	T.B.D	T.B.D	T.B.D	mW
	Black	P <sub>b</sub>	T.B.D	T.B.D	T.B.D	mW
	Vertical Stripe	P <sub>v</sub>	T.B.D	T.B.D	T.B.D	mW

Note:

The recommended operating conditions refer to a range in which operation of this product is guaranteed. Should this range is exceeded, the operation cannot be guaranteed even if the values may be without the absolute maximum ratings.

Accordingly, please make sure that the module is used within this range. And these current values are measured under the condition that all devices are stopped, each component is stable and logic signal is input.

## 5. Optical Specification

ITEM	SYMBOL	CONDITION	Min.	TYP.	Max.	
Color Filter Chromacity (Note.1)	White	x	$\theta = \phi = 0^\circ$	0.287	0.307	0.327
		y		0.321	0.341	0.361
		Y		29.0	32.0	35.0
	Red	x	$\theta = \phi = 0^\circ$	0.633	0.653	0.673
		y		0.312	0.332	0.352
		Y		15.55	18.55	21.55
	Green	x	$\theta = \phi = 0^\circ$	0.294	0.314	0.334
		y		0.555	0.575	0.595
		Y		58.71	61.71	64.71
	Blue	x	$\theta = \phi = 0^\circ$	0.117	0.137	0.157
		y		0.113	0.133	0.153
		Y		13.79	15.79	18.79
Transmittance(%) (Note.3)	T	$\theta = \phi = 0^\circ$	--	5	--	

Note.1 These items are measured by C light.

Note.2 Definition of Viewing Angle( $\theta, \psi$ ), refer to Fig.1 as below :

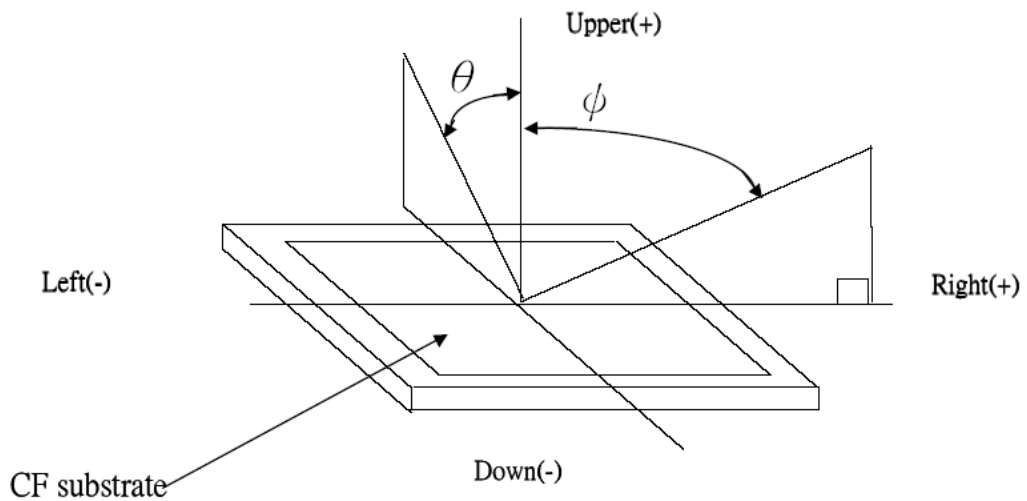
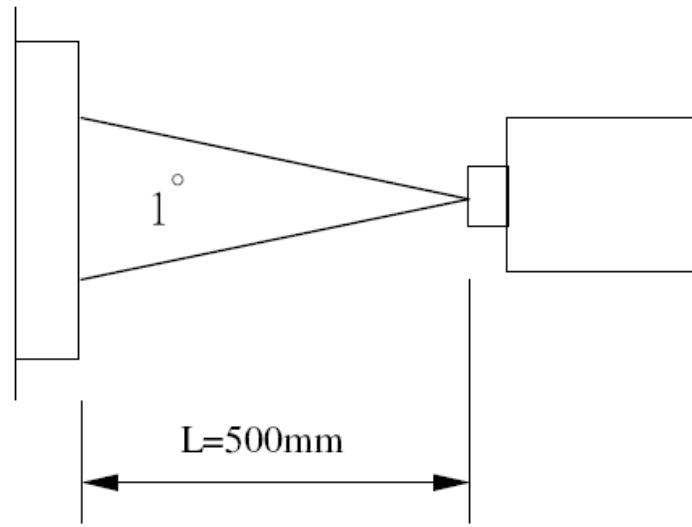
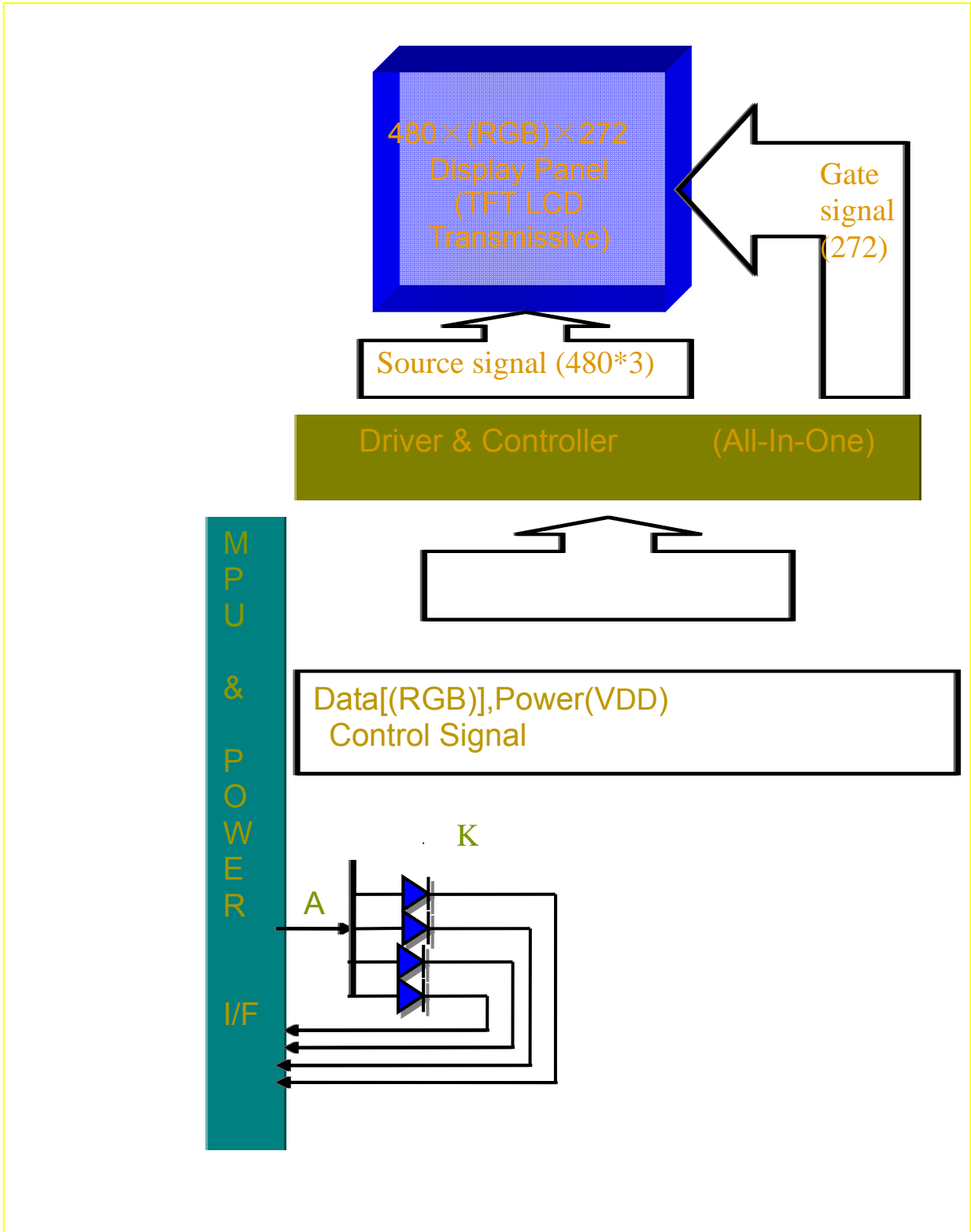

Fig.1 Definition of Viewing Angle

Note.3 Using LC+ EWV Polarizer+Corresponding Backlight, reference only, Measure device : BM-5A (TOPCON) , viewing cone=  $1^\circ$  ,  $I_L=20mA$  .



## 6. Block Diagram





## 7. Pin Description

Pin NO.	Symbol	Description
1	LEDK	LED BACKLIGHT(CATHODE)
2	LEDA	LED BACKLIGHT(ANODE)
3	GND	GROUND
4	VCC	POWER SUPPLY
5	R0	RED DATA
6	R1	RED DATA
7	R2	RED DATA
8	R3	RED DATA
9	R4	RED DATA
10	R5	RED DATA
11	R6	RED DATA
12	R7	RED DATA
13	NC	NC
14	NC	NC
15	NC	NC
16	NC	NC
17	NC	NC
18	NC	NC
19	NC	NC
20	NC	NC
21	NC	NC
22	NC	NC
23	NC	NC
24	NC	NC
25	NC	NC
26	NC	NC
27	NC	NC
28	NC	NC
29	GND	GROUND
30	CLK	CLOCK SIGNAL
31	DISP	DISPLAY ON/OFF
32	HSYNC	HORIZONTAL SYNC INPUT IN RGB MODE
33	VSYNC	VERTICAL SYNC INPUT IN RGB MODE
34	DEN	DATA ENABLE
35	NC	NC
36	GND	GROUND
37	XR(NC)	TOUCH PLANE PIN/NC
38	YD(NC)	TOUCH PLANE PIN/NC
39	XL(NC)	TOUCH PLANE PIN/NC
40	YU(NC)	TOUCH PLANE PIN/NC

# 3 Outline Dimension

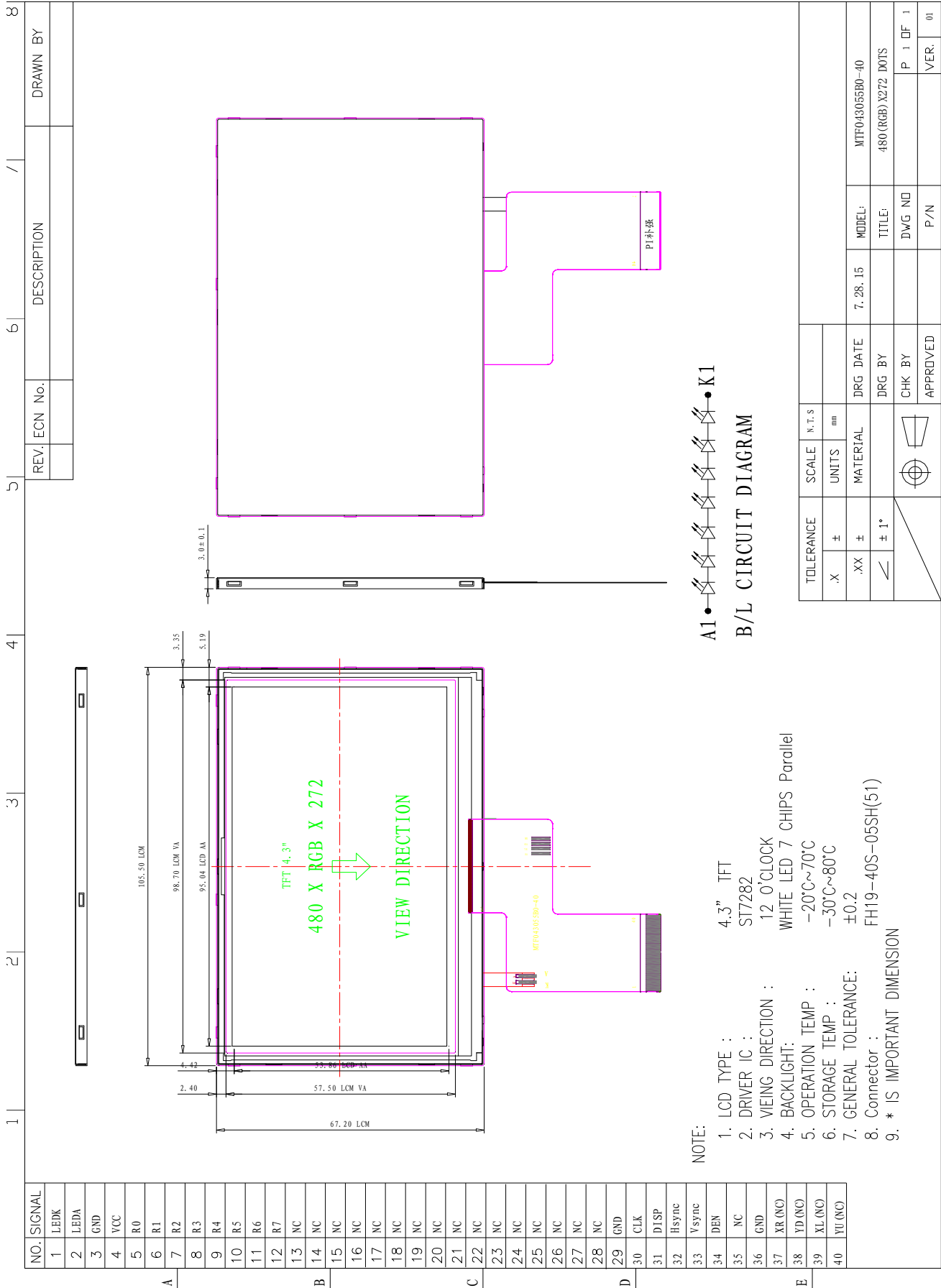

A1 ••••• K1  
B/L CIRCUIT DIAGRAM

- NOTE:
1. LCD TYPE : 4.3" TFT
  2. DRIVER IC : ST7282
  3. VIEWING DIRECTION : 12 O'CLOCK
  4. BACKLIGHT: WHITE LED 7 CHIPS Parallel
  5. OPERATION TEMP : -20°C~70°C
  6. STORAGE TEMP : -30°C~80°C
  7. GENERAL TOLERANCE: ±0.2
  8. Connector : FH19-40S-05SH(51)
  9. \* IS IMPORTANT DIMENSION

TOLERANCE	SCALE	N.T.S	DRG DATE	7.28.15	MODEL	MTF04305B0-40
.X ±	UNITS	mm	DRG BY		TITLE	480 (RGB) X272 DOTS
.XX ±	MATERIAL		CHK BY		DWG NO	P 1 OF 1
∠ ± 1°			APPROVED		P/N	VER. 01

## 9. Timing Characteristics

### 10.1.2 Series 8-bit RGB Timing Table

Item	Symbol	Min.	Typ.	Max.	Unit	Remark	
DCLK Frequency	Fclk	24	27	30	MHz		
DCLK Period	Tclk	33	37	42	ns		
HSYNC	Period Time	Th	1560	1716	1900	DCLK	
	Display Period	Thdisp		1440		DCLK	
	Back Porch	Thbp	108	129	255	DCLK	By H_Blanking setting
	Front Porch	Thfp	12	147	205	DCLK	
	Pulse Width	Thw	1	1	50	DCLK	
VSYNC	Period Time	Tv	274	288	335	H	
	Display Period	Tvdisp		272		H	
	Back Porch	Tvbp	1	12	32	H	By V_Blanking setting
	Front Porch	Tvfp	1	4	31	H	
	Pulse Width	Tvw	1	10	30	H	

## 9.2. Timing Characteristics

Normal Write Mode(HWM='0'), IOVcc=1.65V~3.6V,Vcc=2.5V~3.6V

Parameter	Symbol	Unit	Min.	Max.	Unit
Bus cycle time write	t <sub>CYCW</sub>	ns	100	-	-
Bus cycle time read	t <sub>CYCR</sub>	ns	160	-	-
Write low-level pulse width	PW <sub>LW</sub>	ns	35	-	-
Read low-level pulse width	PW <sub>LR</sub>	ns	45	-	-
Write high-level pulse width	PW <sub>HW</sub>	ns	35	-	-
Read high-level pulse width	PW <sub>HR</sub>	ns	90	-	-
Write/Read rise/fall time	t <sub>WR,WRf</sub>	ns	-	-	25
Setup time Write	t <sub>AS</sub>	ns	0	-	-
Setup time Read	t <sub>AS</sub>	ns	10	-	-
Address hold time	t <sub>AH</sub>	ns	2	-	-
Write data setup time	t <sub>DSW</sub>	ns	25	-	-
Write data hold time	t <sub>H</sub>	ns	5	-	-
Read data delay time	t <sub>DDR</sub>	ns	-	-	100

Read data hold time	t <sub>DHR</sub>	ns	5	-	-
---------------------	------------------	----	---	---	---

### 9.3 Reset Operation

(VCC=1.65~3.1 V)

Table 13-6

Item	Symbol	Unit	Min.	Typ.	Max.
Reset low-level width	tRES	ms	1	-	-
Reset rise time	trRES	μs	-	-	10

## 10. Reliability and Inspection Standard

No.	Test Item	Test Conditions	Remark	
1	High Temperature	Storage	70°C, 120Hr	Note
		Operation	60°C, 120Hr	Note
2	Low Temperature	Storage	-30°C, 120Hr	Note
		Operation	-20°C, 120Hr	
3	High Temperature and High Humidity	60°C, 90%RH, 120Hr	Note	
4	Temperature Cycle	Storage	-10°C(1Hr)→25°C(5min)→60°C(1Hr) 32 Cycles	Note
		Operation	-20°C(1Hr)→25°C(5min)→60°C(1Hr) 25 Cycles	
5	Peeling Off (Storage)	≥ 500gf/cm	Note	
6	FPC Bending Test	≥ 6,000 times, 2/sec	Note	
7	Vibration Test(Storage)	50HZ, 30min, Amplitude: 2 cm, X/Y/Z directions	Note	
8	Drop Test	60cm/ 3Corner/ 8Face, 1Cycle	Note	
9	Electrostatic Discharge	+/-200V,200pf(0ohm) 1 time/each terminal		

Note:

- 1) The test samples should be applied to only one test item.
- 2) Sample size for each test item is 5~10pcs.
- 3) For Damp Proof Test, pure water(Resistance>1MΩ) should be used.
- 4) In case of malfunction defect caused by ESD damage, if it would be recovered to normal

- state after resetting, it would be judged as a good part.
- 5) EL evaluation should be excepted from reliability test with humidity and temperature: Some defects such as black spot/blemish can happen by natural chemical reaction with humidity and fluorescence EL has.
  - 6) After the reliability test, the test samples should be inspected after 2 hours at least.
  - 7) Functional test is OK. Missing segment, shorts, unclear segment, non display, display abnormally, liquid crystal leak are not allowed.
  - 8) After testing, the current Idd should be within initial value  $\pm 20\%$ .
  - 9) No low temperature bubbles ,end seal loose and fall, frame rainbow, ACF bubble growing are allowable in the appearance test.

## 11. Inspection Criterion

### 11.1. Sampling Method

Unless otherwise agreed upon in writing, the sampling inspection shall be applied to the Customer's incoming inspection.

- 1) Lot size: Quantity per shipment lot
- 2) Sampling type: Normal inspection , single sampling
- 3) Inspection level: II
- 4) Sampling table: MIL-STD-105D
- 5) Acceptable Quality Level(AQL): Major=0.65 Minor=1.5

### 11.2. Inspection Method

- 1) Ambient Condition:
  - a. Temperature: Room temperature  $25\pm 5^{\circ}\text{C}$
  - b. Illumination: Single fluorescent lamp non-directive(300 to 700 Lux)
- 2) Viewing distance  
The distance between the LCD and the inspector' s eyes shall be at least 30-50cm.
- 3) Viewing Angle  
The inspection shall be conducted within normal viewing angle range.

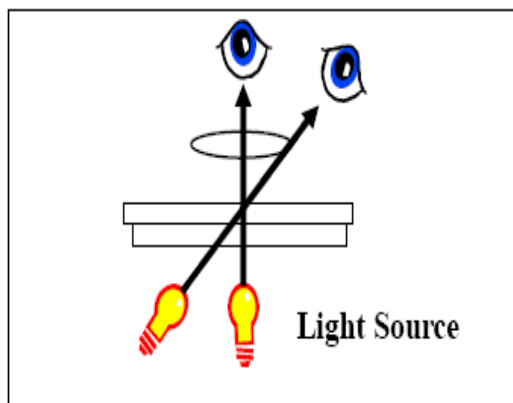

## 12.3. Inspection Criteria

### 12.3.1. Major defect

No.	Item	Inspection Standard	Classification
-----	------	---------------------	----------------

			of defects
1	All functional defects	1) No display 2) Display abnormally 3) Open or missing segment 4) Short circuit 5) Excess power consumption 6) Backlight no lighting, flickering and abnormal lighting	Major
2	Missing	Missing component	Major
3	Outline dimension	Overall outline dimension beyond the drawing is not allowed	Major

### 12.3.2. Cosmetic Defect

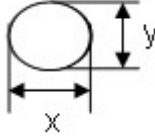
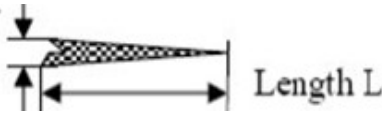
No.	Item	Inspection Standard		Classification of defects						
1	(spot defect) Black and White spot pinhole	For dark/white spot, size $\Phi$ is defined as $\Phi=(x+y)/2$		Minor						
		<table border="1"> <thead> <tr> <th>Size <math>\Phi</math> (mm)</th> <th>Acceptable Quantity</th> </tr> </thead> <tbody> <tr> <td><math>\Phi \leq 0.1</math></td> <td>Ignore</td> </tr> <tr> <td><math>0.10 \leq \Phi \leq 0.15</math></td> <td>2</td> </tr> <tr> <td><math>0.15 \leq \Phi \leq 0.2</math></td> <td>1</td> </tr> <tr> <td><math>0.2 &lt; \Phi</math></td> <td>0</td> </tr> </tbody> </table>	Size $\Phi$ (mm)		Acceptable Quantity	$\Phi \leq 0.1$	Ignore	$0.10 \leq \Phi \leq 0.15$	2	$0.15 \leq \Phi \leq 0.2$
Size $\Phi$ (mm)	Acceptable Quantity									
$\Phi \leq 0.1$	Ignore									
$0.10 \leq \Phi \leq 0.15$	2									
$0.15 \leq \Phi \leq 0.2$	1									
$0.2 < \Phi$	0									
2	(line defect) Black and White line Polarizer scratch	Define: 		Minor						
		<table border="1"> <thead> <tr> <th>Width(mm)</th> <th>Length(mm); Acceptable Qty</th> </tr> </thead> <tbody> <tr> <td><math>\Phi \leq 0.03</math></td> <td>Ignore</td> </tr> <tr> <td><math>0.03 &lt; W \leq 0.05</math></td> <td><math>L \leq 3.0</math>; <math>N \leq 2</math></td> </tr> <tr> <td><math>0.05 &lt; W \leq 0.1</math></td> <td><math>L \leq 2.0</math>; <math>N \leq 2</math></td> </tr> <tr> <td><math>0.1 &lt; W</math></td> <td>Define as spot defect</td> </tr> </tbody> </table>	Width(mm)		Length(mm); Acceptable Qty	$\Phi \leq 0.03$	Ignore	$0.03 < W \leq 0.05$	$L \leq 3.0$ ; $N \leq 2$	$0.05 < W \leq 0.1$
Width(mm)	Length(mm); Acceptable Qty									
$\Phi \leq 0.03$	Ignore									
$0.03 < W \leq 0.05$	$L \leq 3.0$ ; $N \leq 2$									
$0.05 < W \leq 0.1$	$L \leq 2.0$ ; $N \leq 2$									
$0.1 < W$	Define as spot defect									

3	Polarizer defect	Dent or bubble(between the polarizer and glass)		Minor
		Size $\Phi$ (mm)	Acceptable Qty	
		$\Phi \leq 0.10$	Ignor	
		$0.10 < \Phi \leq 0.20$	2	
		$0.20 < \Phi \leq 0.30$	1	
		$0.30 < \Phi$	0	

### 12.3.3. Cosmetic Defect

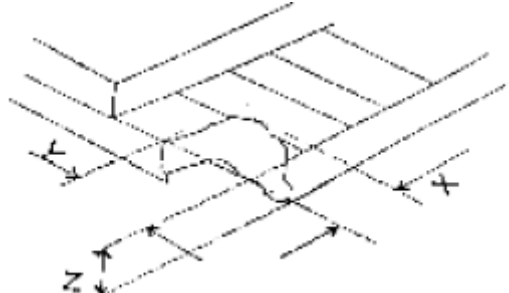
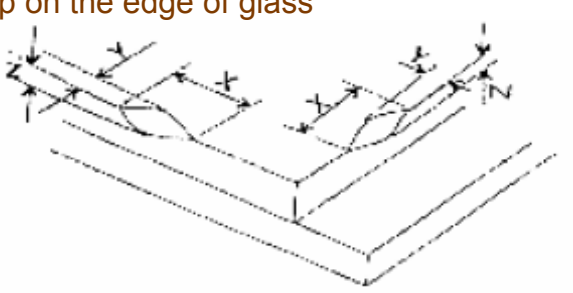
No.	Item	Inspection Standard	Classification of defects						
1	Glass defect	1) Chip on the corner  <table border="1" style="margin: 10px auto;"> <tr> <td style="text-align: center;">X</td> <td style="text-align: center;">Y</td> <td style="text-align: center;">Z</td> </tr> <tr> <td style="text-align: center;"><math>\leq 3.0</math></td> <td style="text-align: center;"><math>\leq S</math></td> <td style="text-align: center;"><math>\leq T</math></td> </tr> </table> <p>Remark: S=contact pad length; T=the thickness of glass Chips on the corner of terminal shall not be allowed to extend into the ITO pad or expose perimeter seal. Acceptable Quantity <math>N \leq 2</math>.</p>	X	Y	Z	$\leq 3.0$	$\leq S$	$\leq T$	Minor
		X	Y	Z					
$\leq 3.0$	$\leq S$	$\leq T$							
		2) Chip on the edge of glass  <table border="1" style="margin: 10px auto;"> <tr> <td style="text-align: center;">X</td> <td style="text-align: center;">Y</td> <td style="text-align: center;">Z</td> </tr> </table>	X	Y	Z	Minor			
X	Y	Z							

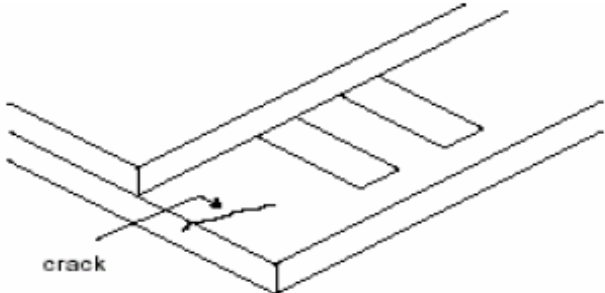
	Ignore	$\leq 0.5$	$\leq T$	
	Acceptable Quantity: $N \leq 2$			
	3) Creak Creaks tend to break are not allowed.			Minor
				

## ■ PRECAUTIONS FOR USING LCD MODULES

### Handing Precautions

- (1) The display panel is made of glass and polarizer. As glass is fragile, it tends to become or chipped during handling especially on the edges. Please avoid dropping or jarring. Do not subject it to a mechanical shock by dropping it or impact.
- (2) If the display panel is damaged and the liquid crystal substance leaks out, be sure not to get any in your mouth. If the substance contacts your skin or clothes, wash it off using soap and water.
- (3) Do not apply excessive force to the display surface or the adjoining areas since this may cause the color tone to vary. Do not touch the display with bare hands. This will stain the display area and degraded insulation between terminals (some cosmetics are determined to the polarizer).
- (4) The polarizer covering the display surface of the LCD module is soft and easily scratched. Handle this polarizer carefully. Do not touch, push or rub the exposed polarizers with anything harder than an HB pencil lead (glass, tweezers, etc.). Do not put or attach anything on the display area to avoid leaving marks on. Condensation on the surface and contact with terminals due to cold will damage, stain or dirty the polarizer. After products are tested at low temperature they must be warmed up in a container before coming is contacting with room temperature air.
- (5) If the display surface becomes contaminated, breathe on the surface and gently wipe it with a soft dry cloth. If it is heavily contaminated, moisten cloth with one of the following solvents
  - Isopropyl alcohol
  - Ethyl alcohol
Do not scrub hard to avoid damaging the display surface.
- (6) Solvents other than those above-mentioned may damage the polarizer. Especially, do not use the following.
  - Water
  - Ketone
  - Aromatic solvents
Wipe off saliva or water drops immediately, contact with water over a long period of time may cause deformation or color fading. Avoid contacting oil and fats.
- (7) Exercise care to minimize corrosion of the electrode. Corrosion of the electrodes is



---

accelerated by water droplets, moisture condensation or a current flow in a high-humidity environment.

- (8) Install the LCD Module by using the mounting holes. When mounting the LCD module make sure it is free of twisting, warping and distortion. In particular, do not forcibly pull or bend the I/O cable or the backlight cable.
- (9) Do not attempt to disassemble or process the LCD module.
- (10) NC terminal should be open. Do not connect anything.
- (11) If the logic circuit power is off, do not apply the input signals.
- (12) Since LCM has been assembled and adjusted with a high degree of precision, avoid applying excessive shocks to the module or making any alterations or modifications to it.
  - Do not alter, modify or change the shape of the tab on the metal frame.
  - Do not make extra holes on the printed circuit board, modify its shape or change the positions of components to be attached.
  - Do not damage or modify the pattern writing on the printed circuit board.
  - Absolutely do not modify the zebra rubber strip (conductive rubber) or heat seal connector.
  - Except for soldering the interface, do not make any alterations or modifications with a soldering iron.
  - Do not drop, bend or twist LCM.

## Storage Precautions

When storing the LCD modules, the following precaution is necessary.

- (1) Store them in a sealed polyethylene bag. If properly sealed, there is no need for the dessicant.
- (2) Store them in a dark place. Do not expose to sunlight or fluorescent light, keep the temperature between 0°C and 35°C.
- (3) The polarizer surface should not come in contact with any other objects. (We advise you to store them in the container in which they were shipped).

## Others

Liquid crystals solidify under low temperature (below the storage temperature range) leading to defective orientation or the generation of air bubbles (black or white). Air bubbles may also be generated if the module is subject to a low temperature.

If the LCD modules have been operating for a long time showing the same display patterns, the display patterns may remain on the screen as ghost images and a slight contrast irregularity may also appear. A normal operating status can be regained by suspending use for some time. It should be noted that this phenomenon does not adversely affect performance reliability.

To minimize the performance degradation of the LCD modules resulting from destruction caused by static electricity etc., exercise care to avoid holding the following sections when handling the modules.

- Exposed area of the printed circuit board.
- Terminal electrode sections.