

Total solder points: 166 + 116
Difficulty level: beginner 2 3 4 5 advanced

THERMOSTAT WITH LCD-DISPLAY

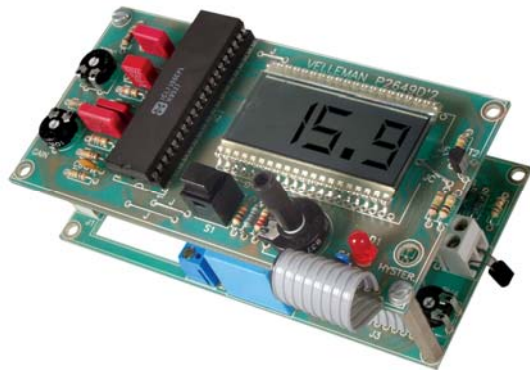

K2649

Digital readout of both set and actual temperature.

The very precise digital display of both the set and actual temperature makes this thermostat very easy to use.

Also very useful is the connecting capability for an 'economy switch': when the contact is closed then the set temperature is decreased by a number of degrees.

No measuring apparatus is needed for adjustments. Thanks to the wide setting range of both the hysteresis and the desired temperature, this kit can also be used for a lot more applications than only regulating room temperature.

Features:

- ☑ Wide measuring and regulating range: -50 to +150°C (-60 to +300°).
- ☑ Adjustable hysteresis: 0,2°C (0,4°F) to 10°C (18°F).
- ☑ Resolution of the display: 0,1°C or 1°F.
- ☑ Can be set for degrees Celsius or Fahrenheit.
- ☑ Connecting capability for economy switch.

Specifications:

- Power supply and transformer included.
- Mains voltage: 220/240V (110 for USA and Canada).
- Relay output: 240V, 3A max.
- Dimensions: 123.5x62x65 mm.

1. Assembly (Skipping this can lead to troubles !)

Ok, so we have your attention. These hints will help you to make this project successful. Read them carefully.

1.1 Make sure you have the right tools:

- A good quality soldering iron (25-40W) with a small tip.
- Wipe it often on a wet sponge or cloth, to keep it clean; then apply solder to the tip, to give it a wet look. This is called 'thinning' and will protect the tip, and enables you to make good connections. When solder rolls off the tip, it needs cleaning.
- Thin raisin-core solder. Do not use any flux or grease.
- A diagonal cutter to trim excess wires. To avoid injury when cutting excess leads, hold the lead so they cannot fly towards the eyes.
- Needle nose pliers, for bending leads, or to hold components in place.
- Small blade and Phillips screwdrivers. A basic range is fine.

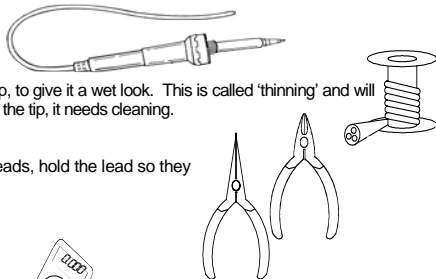

For some projects, a basic multi-meter is required, or might be handy

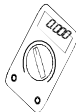

1.2 Assembly Hints :

- ⇒ Make sure the skill level matches your experience, to avoid disappointments.
- ⇒ Follow the instructions carefully. Read and understand the entire step before you perform each operation.
- ⇒ Perform the assembly in the correct order as stated in this manual
- ⇒ Position all parts on the PCB (Printed Circuit Board) as shown on the drawings.
- ⇒ Values on the circuit diagram are subject to changes.
- ⇒ Values in this assembly guide are correct*
- ⇒ Use the check-boxes to mark your progress.
- ⇒ Please read the included information on safety and customer service

* Typographical inaccuracies excluded. Always look for possible last minute manual updates, indicated as 'NOTE' on a separate leaflet.

1.3 Soldering Hints :

1- Mount the component against the PCB surface and carefully solder the leads

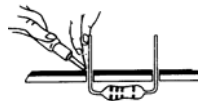

2- Make sure the solder joints are cone-shaped and shiny

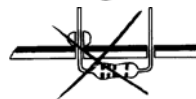

3- Trim excess leads as close as possible to the solder joint

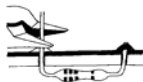

AXIAL COMPONENTS ARE TAPED IN THE CORRECT MOUNTING SEQUENCE !

REMOVE THEM FROM THE TAPE ONE AT A TIME !

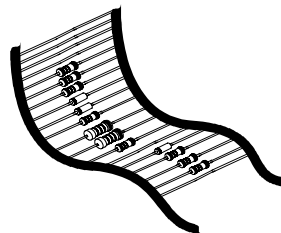

You will find the colour code for the resistances and the LEDs on our website:
<http://www.velleman.be/common/service.aspx>

A. POWER SUPPLY MODE 'P2649V'**1. Diode. Watch the polarity !**

D5 : 1N4148

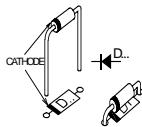
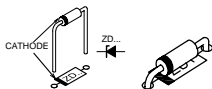
**2. Zenerdiode. Watch the polarity !**

ZD1 : 8V2 - 500mW.

3. Diodes. Watch the polarity !

D1 : 1N4007
 D2 : 1N4007
 D3 : 1N4007
 D4 : 1N4007

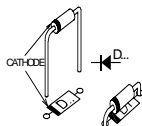
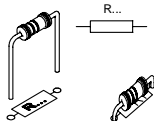
**4. Resistors**

R1 : 560 (5-6-1-B)
 R3 : 100K (1-0-4-B)
 R4 : 100K (1-0-4-B)
 R6 : 100K (1-0-4-B)
 R15 : 220K (2-2-4-B)
 R16 : 220K (2-2-4-B)
 R17 : 560K (5-6-4-B)
 R18 : 560K (5-6-4-B)
 R26 : 820 (8-2-1-B)
 R27 : 1K (1-0-2-B)
 R28 : 10K (1-0-3-B)
 R29 : 82 (8-2-0-B)
 R34 : 6K8 (6-8-2-B)
 R35 : 5M6 (5-6-5-B)

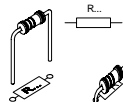
5. Metal film resistors

R20 : 10K (1-0-0-2-1)
 R21 : 10K (1-0-0-2-1)
 R22 : 47K (4-7-0-2-1)
 R23 : 47K (4-7-0-2-1)

6. IC socket, Watch the position of the notch !

IC2 : 14P

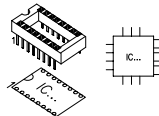

7. Ceramic capacitor.

□ C3 : 100nF (104)



8. Transistor.

□ T1 : BC557B

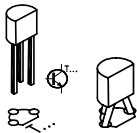

9. Horizontal trimmer

□ RV4 : :10K

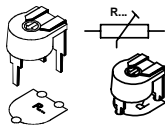

10. Capacitor

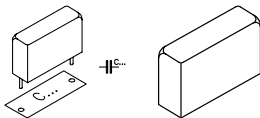

□ C10 : 1µF/63V

11. Vertical trimmer

□ RV5 : :4M7 (5M)

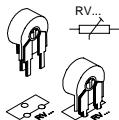

12. Terminal blocks.

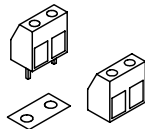

- J1 : Mains.
- J4 : "ES" Economy switch.

□ J2 :

- For heaters use the contacts : 'C' & 'NO'.
- For coolers use the contacts : 'C' & 'NC'.



The connection side of the connectors must point to the PCB-opening!

13. Electrolytic Capacitor. Watch the polarity !

C2 : 100 μ F

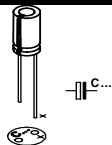

14. Fuse holder & Fuse

F1 : 100mA
(slow)

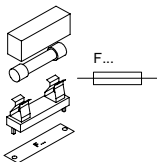

15. Relay

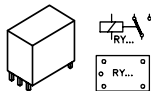

RY1 : VR15M121C

16. Electrolytic Capacitor. Watch the polarity !

C1 : 1000 μ F

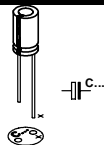

17. Transformer

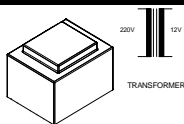

TRAFO1 : 12V - 0,1A

18. IC. Watch the position of the notch!

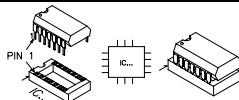

IC2 : LM324

19. Flat cable

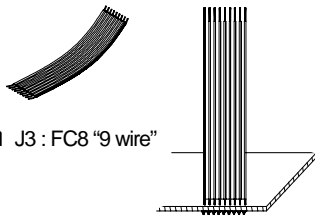

J3 : FC8 "9 wire"

20. Choosing hysteresis

• Small hysteresis

If you desire a small hysteresis (adjustable from 0,2 to 1°C or from 0,4 to 4°F), then fit for R24 and R25 a 180K metal film resistor (brown, grey, black, orange).

• Larger hysteresis

If you prefer a larger hysteresis (between 1 and 10°C or 2 and 20°F, for instance for water heaters and such-like), then fit a wire link for R24 and R25.

B. DISPLAY MODULE 'P2649D'

1. Jumpers

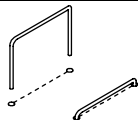

- J (4x)

Choose temperature display :

- JC for °C
 JF for °F

2. Metal film resistor

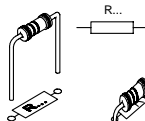

- R2 : 91K (9-1-0-2)

3. Resistors

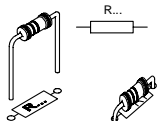

- R5 : 100K (1-0-4-B)
 R9 : 1K8 (1-8-2-B)
 R11 : 120K (1-2-4-B)
 R12 : 18K (1-8-3-B)
 R19 : 4M7 (4-7-5-B)
 R30 : 47K (4-7-3-B)
 R31 : 10K (1-0-3-B)
 R33 : 22K (2-2-3-B)

Mount for R10 :

- 390 (3-9-1-B) for °C.
OR
 330 (3-3-1-B) for °F.

Mount for R13 :

- 1M (1-0-5-B) for °C.
OR
 150K (1-5-4-B) for °F.

☞ For degrees Celsius, the following resistors must be fitted too :

- R7 : 100K (1-0-4-B)
 R8 : 100K (1-0-4-B)
 R14 : 150K (1-5-4-B)

4. IC socket, Watch the position of the notch !

- IC1 : 40P

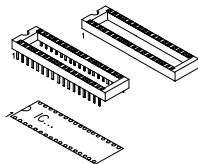

5. Ceramic capacitors.

- C4 : 100nF (104)
- C6 : 100pF (101)

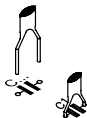

6. Transistor.

- T2 : BC557B

Attention : For °F this transistor should not be fitted!

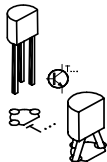

7. Horizontal trimmers

- RV1 : 4K7
- RV2 : 100
- RV3 : 10K

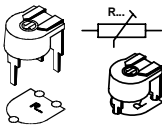

8. LCD display

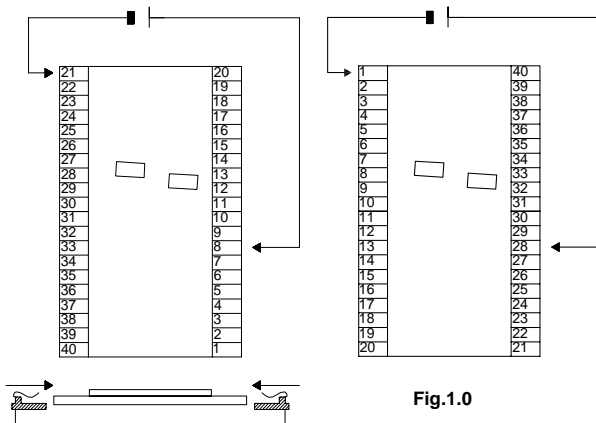

Fig.1.0

☞ **First look for pin 1 :** if a colon is displayed when connecting the battery, then you have the display correctly mounted. If only one point is displayed, then you have to turn the display, fig. 1.0.

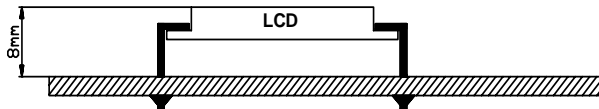

Fig. 2.0

Pay attention to the position : the upper surface must be at 8mm (0,3 inch) above the pcb surface (see drawing 2.0).

You may put some pieces of paper between the LCD and the pcb, to help you holding the display on the right height.

- First solder only the pins at the four corners.
- Verify the height, and correct if necessary.
- Then solder the remaining pins.

Be very careful, for this part is not cheap!

9. Capacitors

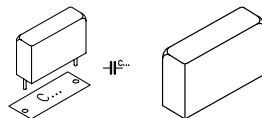

- C5 : 10nF / 250V
- C7 : 100nF / 250V
- C8 : 220nF / 100V
- C9 : 470nF / 63V

10. LED. Watch the polarity !

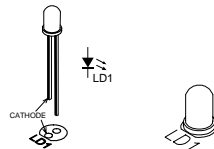

- LD1: 5mm Red

11. Push button.

□ S1 : S500

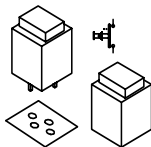
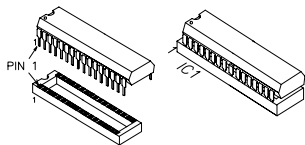
**12. IC. Watch the position of the notch!**

□ IC1 : ICL7106

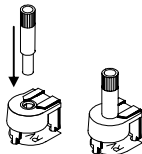
13. Axe.

Insert the plastic spindle in trimmer RV1 as displayed.

14. Sensor

Calibration is performed by alternately adjusting the meter at the freezing respectively boiling-point of water. Therefore the sensor first has to be prepared.

👉 **DON'T** shorten the connection wires of the sensor, unless you are not going to fit it directly onto the pcb in the future.

☐ Solder two isolated wires (75 cm or 30") to the sensor (see fig. 3.0)

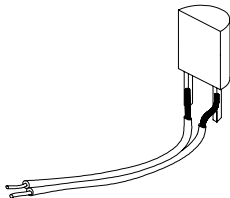
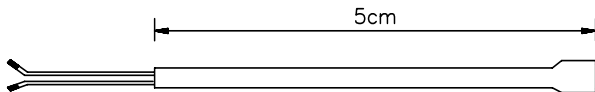

Fig. 3.0

Make use of a cable of the desired length (max 10m, and preferably screened to avoid interferences) if you are not going to fit the sensor onto the pcb in the future.

Make the connections waterproof with heat-shrinkable tubing :

- Cut off a piece of shrinking tube with a length equal to 5cm.
- Slide the shrinking tube over the wires and over the sensor (Fig. 4.0).
- Heat the shrinking tube using a hair dryer or, better still, using a paint stripper.

**Fig. 4.0**

 **Take care** that everything is well covered.

Connect the whole to the place marked with 'R32 SENSOR'. The connection order is unimportant, unless with screened cable: the screen then comes on the side marked with 'SENSOR'. Connect a mains cable to the screw connector J1-MAINS.

15. Flat cable

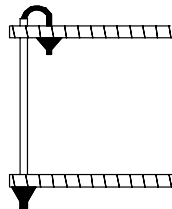
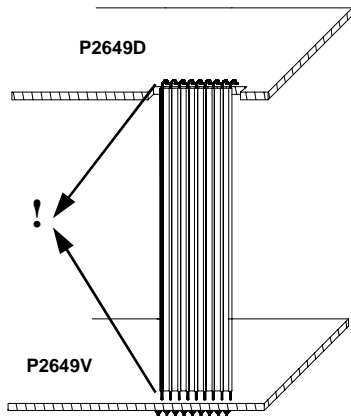

Fig. 5.0

Attention : The connecting order (whit regard to the pcb-edge) must be the same as on the power supply module (see fig. 5.0).

16. Adjustment

During assembly you already made your choice for degrees Celsius or degrees Fahrenheit version. The adjusting method is the same for both, only the values on the display are different. The figures for Fahrenheit are mentioned within brackets.

The first adjustment is done at the freezing-point.

- Fill a beaker with ice cubes and plunge the sensor into the melting-water (Fig. 6.0). As long as not all the ice is molten, the temperature of the melting-water is kept at 0°C (32°F), and after a few minutes the sensor will be at 0°C too.



Fig. 6.0

- Then adjust with RV2 until the display reads 00.0 (32°F).
- After zero-adjustment, the sensitivity of the meter has to be adjusted.
- Plunge the sensor into boiling water, but see to it that the sensor does not come too close to the bottom or wall of the kettle.
- After a few minutes, the sensor temperature has risen to 100°C (212°F).
- Then adjust with RV3 until the display reads 100.0 (212°F).
- Now let it cool down for about half an hour, and do the complete adjustment over again once more.



Remark : when the sensor has to be replaced for any reason, then you have to readjust completely!

17. Use

The set temperature is displayed when you push the button S1.

You can change it by gradually turning potentiometer RV1 until the display shows the desired temperature. With the standard values for R2 and R33 (91K resp. 22K), the adjusting range is about 5 to 30°C (40 to 85°F).

You can change this range by using other values for R2 and R33 :

Range	R2	R3
-50°C (-60°F) to 0°C (32°F)	51K	7K5
+50°C (120°F) to 100°C (212°F)	33K	12K
+100°C (212°F) to 150°C (300°F)	33K	16K



You can also experiment yourself in order to obtain an optimum adjusting range for your application.

- Solder a 1M trimmer parallel to both R2 and R33 (see fig. 7.0).
- Adjust both trimmers so that you obtain the optimum range.
- Afterwards replace the trimmers by normal resistors which approximate the set value as close as possible.

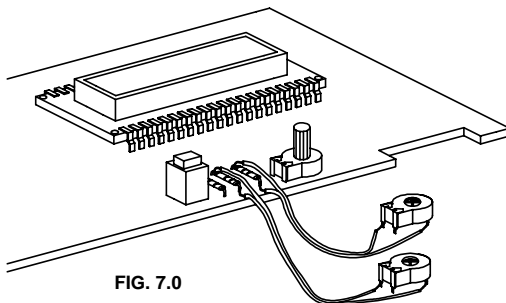

FIG. 7.0

You can lower the set temperature by a number of degrees (preset with RV5), e.g. by night or during your absence, by connecting a switch or a relay contact (e.g. a timer such like K2603 or K1682) at the place marked with 'E.S.' (Economy Switch).

The hysteresis is the difference between the temperatures at which the output is switched on resp. switched off. Depending on the application, a smaller or larger hysteresis may be desired: to regulate the room temperature for instance, a small hysteresis is desirable. On the contrary, this makes no sense with water-heaters, so, in this case, you should select a larger hysteresis.

You can adjust the hysteresis with RV4.

The adjusting range is about 0,2 to 2°C (0,4 to 4°F) when R24 and R25 are 180K resistors, and 1 to 10°C (2 to 18°F) when you fitted wire links.

The setting of the hysteresis does not depend on the set temperature. Do not set the minimum hysteresis right from the beginning: in this case the regulation is most precise, however it could happen that the heating gets switched on and off much too fast and too often (e.g. when the thermostat is located near the radiator). This is not too healthy for the heating installation and/or relay, and too much energy is consumed. Therefore start with RV4 in the middle position, and then search the ideal position for your application.

Suppressing inductive loads :

Should the operation of the thermostat get disturbed by the switching of inductive loads (even if the switched power is not so high), then this is due to the sparks produced in the relay. In most cases this can be remedied by putting a VDR (e.g. VDR300) over the contacts. Moreover a series connection of a 100 ohm resistor with a 47 or 100nF/400V capacitor can be placed in parallel with the VDR in order to further reduce the sparks (see Fig. 8.0).

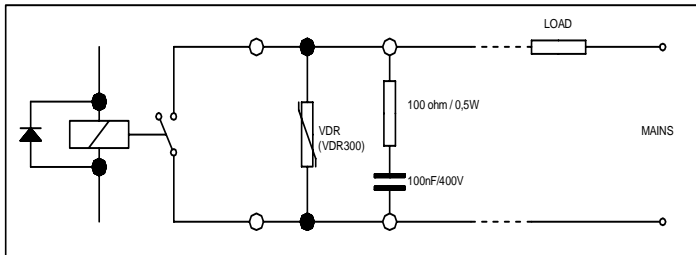

FIG. 8.0

18. Mounting

* Spacers & screws are not included.

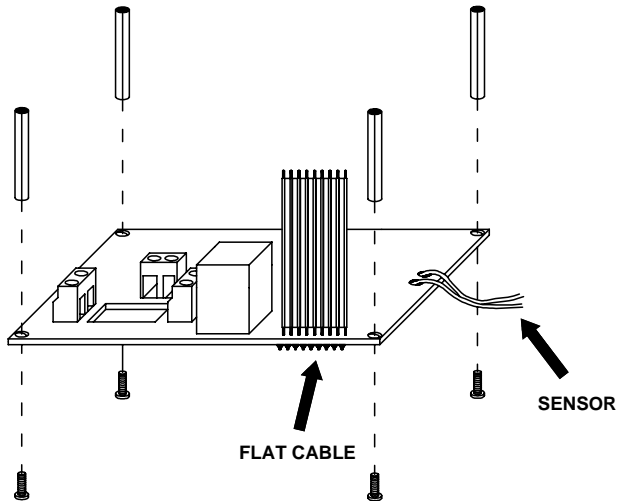
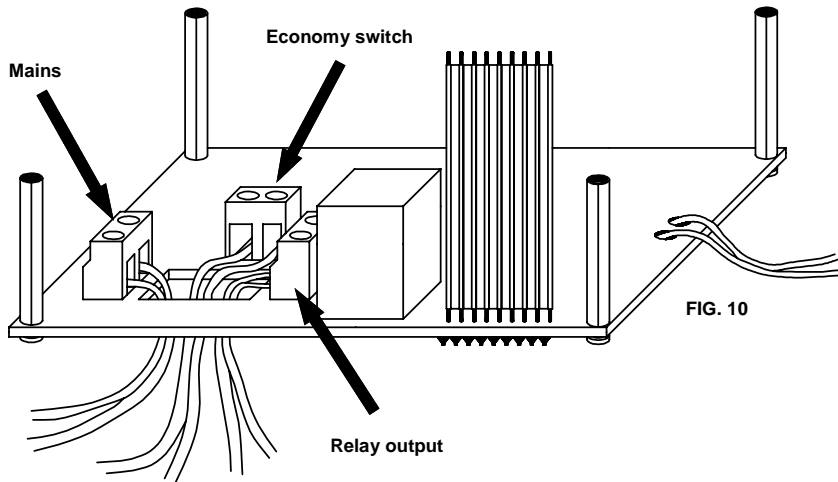

FIG. 9.0

The rectangular opening in the power supply module is used as a passage for the wiring to the mains input, the relay output and the E.S. (Economy Switch), see fig. 10



The display module can be mounted above the power supply module using spacers (See fig. 11).

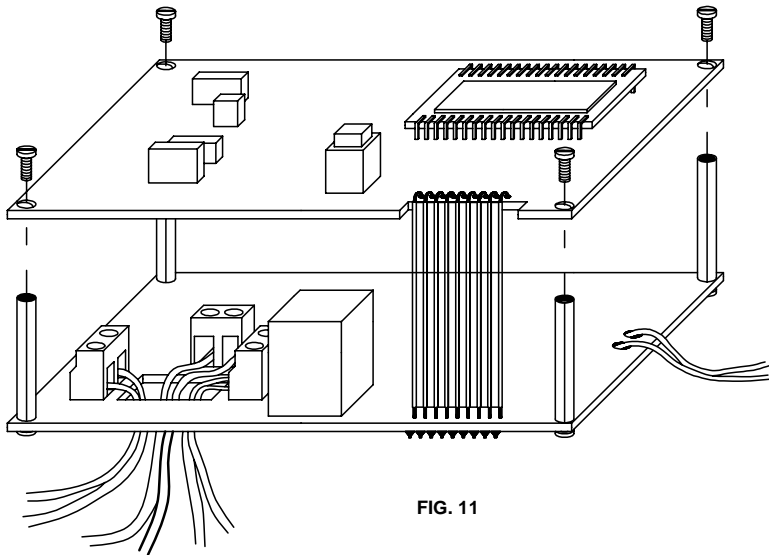

FIG. 11

This thermostat exactly fits into the box type B2649.

In case you use this box, you can fit the sensor onto the pcb in such a way that it passes through the opening in the side of the bottom. In this way, the sensor reacts more quickly and accurately upon the room temperature, and it doesn't get influenced by the heat-dissipation of the transformer and such-like.

In case of panel-mounting, you may use a somewhat longer flat cable, so you can simply mount the pcb's with their solder sides towards each other, and the connections are easily accessible.

You also could use screw connectors for the sensor connection. Wherever and for whatever application the thermostat may be used, always take into account that the mounting of the sensor determines the quality of the regulation: the quicker it reacts upon the changing temperature, the better.

In case of liquids, this is not such a problem: you can attach the sensor on the outside of the metal pipe or boiler (you could use a little bit of heat-conducting paste), or make the sensor waterproof and plunge it into the liquid.

Air however is a much worse heat-conductor, so that the body of the sensor does not heat up/cool down that quickly. This can be improved by circulating the air around the sensor.

Especially in large rooms, which are heated by means of hot air, it can be interesting to place the sensor in the (cold) air circulation, for instance nearby the air inlet of the convector.

The intake air (which has the actual room temperature) then makes the sensor warm up quickly as the room temperature increases.

19. PCB layout (Display module)

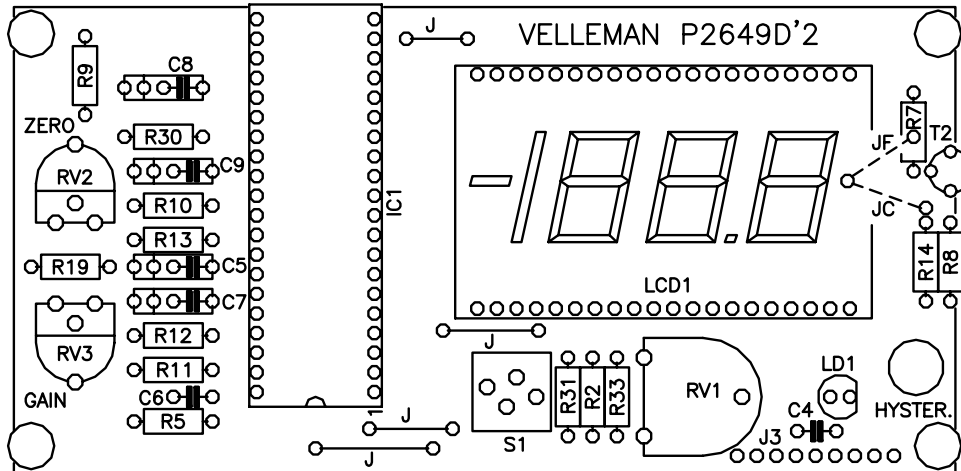



Modifications and typographical errors reserved

© Velleman Components nv.

H2649IP - 2004 - ED1 (rev 2.0)



54103291291853